

DH-PFA110

Mount Adapter



Features

- Aesthetic design
- Material: aluminum
- Mount adapter

Technical Specifications

Model	DH-PFA110
General	
Material	Aluminum
Dimension	Φ59mmx53mm (Φ2.32"x2.09")
Pipe Thread	G1 1/2"
Load Bearing	5.0kg(11.02lb)
Weight	0.2kg(0.44lb)
Color	White
Operating Temperature	-40°C ~ +60°C (-40°F ~ +140°F)
Humidity	<90% RH
Applicable Model	Please see "Accessory Selection"

Order Information

Type	Part Number	Description
Camera Mount	DH-PFA110	Mount adapter
	PFA110	Mount adapter

Dimensions (mm/inch)

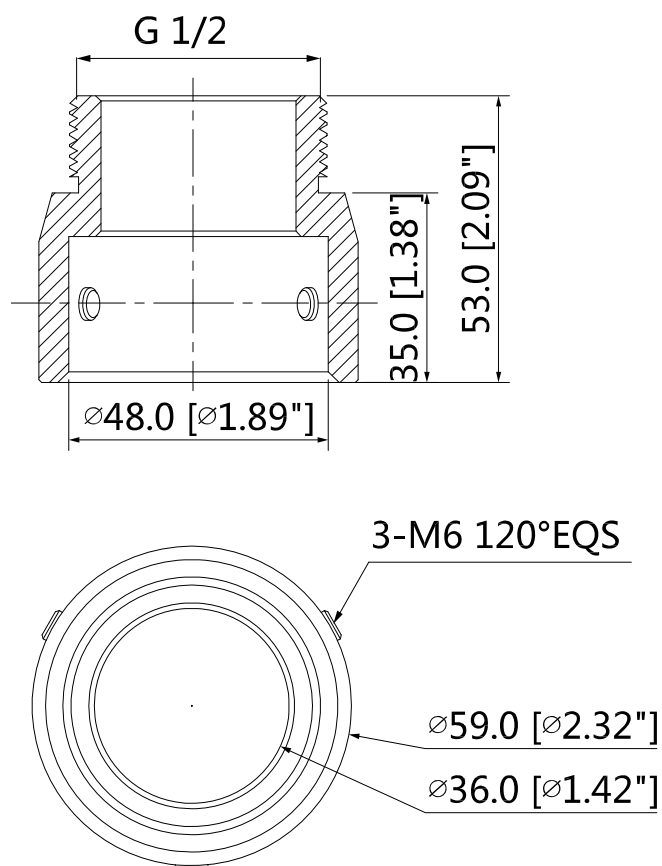

Application

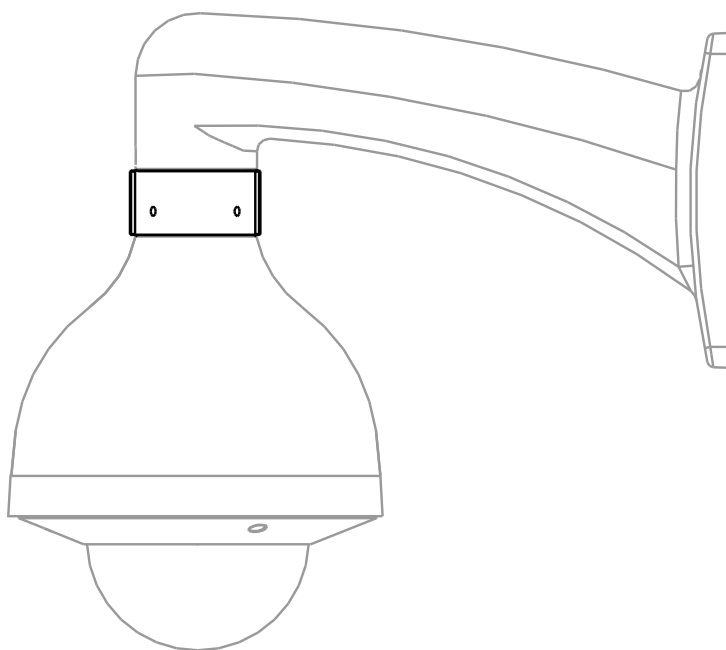

Package Information

- Mount adapter *1